

1	INITIAL RELEASE	JACK WU	2020/03/05
2	NEW FORM	JACK WU	2020/04/01
3			

SPECIFICATION:

- Current Rating: 5A For VBUS Pin ;
1.25A for VCONN Pin ;
0.25A for other Pin.
- Contact Resistance: 40mΩ max initial ;
10mΩ change after Test
- Insulation Resistance : 100MΩ Min.
- Dielectric Withstanding Voltage: 100V AC For 1Minute
- Insertion Force : 0.5~2.0Kgf.
- Withdrawal Force : 0.8~2.0Kgf
- Durability : 10,000 Cycles
- Operation Temperature: -25°C TO 85°C

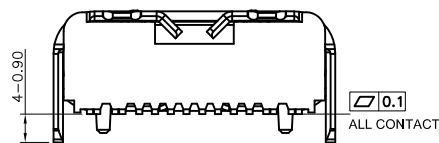
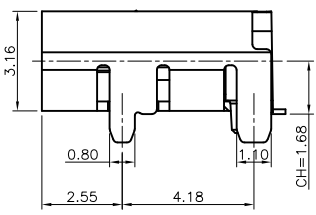
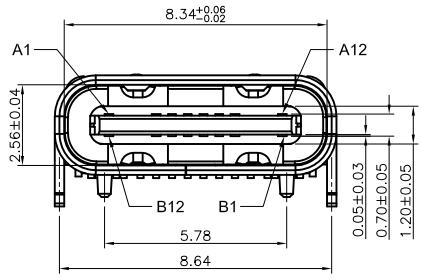
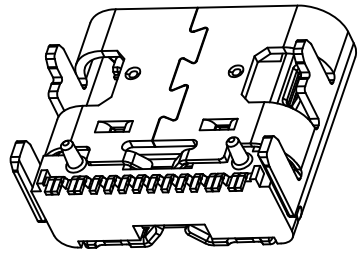
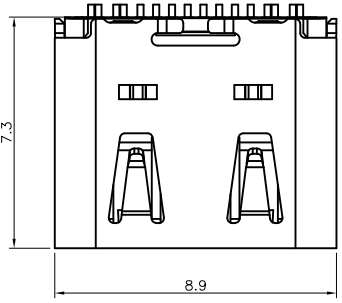

PIN	Signal Name	PIN	Signal Name
A1	GND	B12	GND
A4	VBUS	B9	VBUS
A5	CC1	B8	SBU2
A6	Dp1	B7	Dn2
A7	Dn1	B6	Dp2
A8	SBU1	B5	CC2
A9	VBUS	B4	VBUS
A12	GND	B1	GND
SHELL	GND		

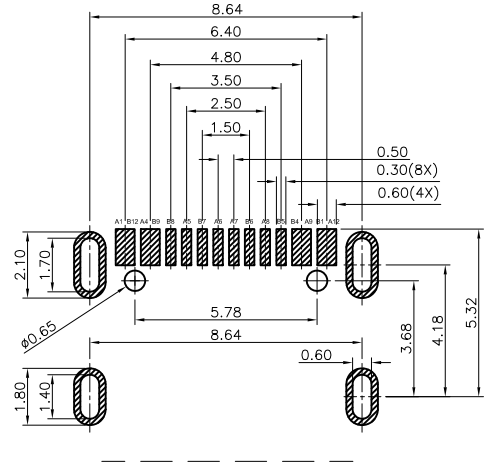
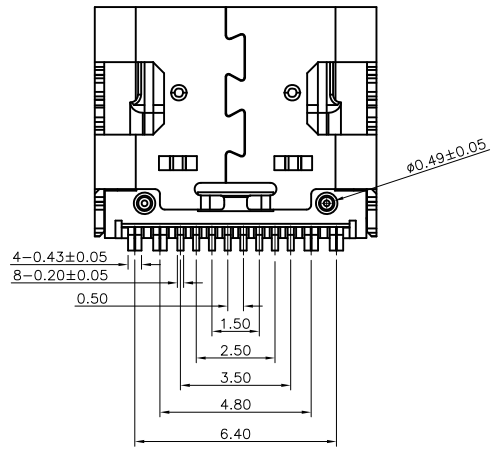

RECOMMEND P.C.B LAYOUT

5.	MID PLATE	SUS 301
4.	SHELL	SUS 304, Ni Plating
3.	CONTACT	C7025, Gold Flash plating on Contact Area, Sn Plating on Solder Tail, Ni Underplating over All
2.	INSERT MOLDING	LCP, UL 94 V-0, Black
1.	BODY	LCP, UL 94 V-0

NO.	PART NAME	DESCRIPTION																
<table border="1"> <tr> <td colspan="2">DIMENSIONS : mm</td> <td rowspan="2"> Chunxin Technology NAME </td> </tr> <tr> <td colspan="2"> TOLERANCES UNLESS OTHERWISE SPECIFIED : X. ± 0.30 X.X ± 0.20 X.XX ± 0.10 ANGLES ± 3° </td> </tr> <tr> <td>SCALE</td> <td>1 : 1</td> <td rowspan="2"> USB Type C 2.0 Receptacle R/A SMT, 16Pin </td> </tr> <tr> <td>SHEET</td> <td>1/1</td> </tr> <tr> <td>SIZE</td> <td>A4</td> <td>PRODUCT No. CX3-UCF16-51</td> </tr> <tr> <td>CUSTOMER DRAWING</td> <td></td> <td>DRAWING No. HI-UC001</td> </tr> </table>			DIMENSIONS : mm		Chunxin Technology NAME	TOLERANCES UNLESS OTHERWISE SPECIFIED : X. ± 0.30 X.X ± 0.20 X.XX ± 0.10 ANGLES ± 3°		SCALE	1 : 1	USB Type C 2.0 Receptacle R/A SMT, 16Pin	SHEET	1/1	SIZE	A4	PRODUCT No. CX3-UCF16-51	CUSTOMER DRAWING		DRAWING No. HI-UC001
DIMENSIONS : mm		Chunxin Technology NAME																
TOLERANCES UNLESS OTHERWISE SPECIFIED : X. ± 0.30 X.X ± 0.20 X.XX ± 0.10 ANGLES ± 3°																		
SCALE	1 : 1	USB Type C 2.0 Receptacle R/A SMT, 16Pin																
SHEET	1/1																	
SIZE	A4	PRODUCT No. CX3-UCF16-51																
CUSTOMER DRAWING		DRAWING No. HI-UC001																